

AIR COOLED EIGHT MODELS/AO SERIES

HIGH FLOWS

MODERATE HEAT REMOVAL

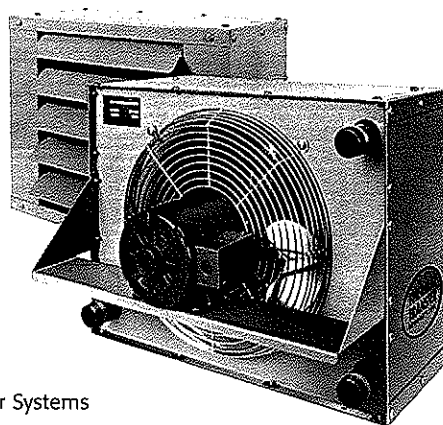

air cooled
AO/AOVH/AOF

- Fluid Power Systems
- Gear Drives
- Injection Molding Machines
- Machine Tools
- Torque Converters
- Hydraulic Presses

OPTIONS:

- Internal SAE Straight Threads
- SAE & Metric Connections
- Relief Bypass
- Foot Brackets

MATERIALS

- Tubes** - Copper
- Fins** - Aluminum
- Turbulators** - Steel
- Fan Blade** - Aluminum with steel hub

- Fan Guard** - Zinc plated steel
- Cabinet** - Steel with baked enamel finish
- Manifolds and Connection Pipes** - Steel

RATINGS

- Operating pressure** - 300 psi
- Test pressure** - 300 psi
- Operating temperature** - 400°F

AOR SERIES

ONE PASS

(MEDIUM TO HIGH OIL FLOWS)

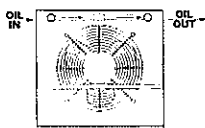

Model	Flow Range GPM (USA)
AOR - 5 - 1	2 - 80
AOR - 10 - 1	3 - 80
AOR - 15 - 1	4 - 80
AOR - 20 - 1	5 - 80
AOR - 25 - 1	6 - 100
AOR - 30 - 1	7 - 100
AOR - 35 - 1	8 - 112
AOR - 40 - 1	9 - 118

AOR SERIES

TWO PASS

(LOW TO MEDIUM OIL FLOWS)

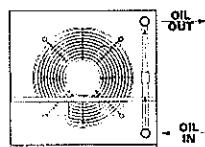

Model	Flow Range GPM (USA)
AOR - 5 - 2	2 - 25
AOR - 10 - 2	2 - 30
AOR - 15 - 2	2 - 30
AOR - 20 - 2	2 - 40
AOR - 25 - 2	2 - 40
AOR - 30 - 2	2 - 40
AOR - 35 - 2	3 - 40
AOR - 40 - 2	4 - 40

Model	Net Weights (LBS.)
AO-5	47
AO-10	62
AO-15	72
AO-20	86
AO-25	120
AO-30	135
AO-35	160
AO-40	185

HOW TO ORDER

	-		-		-		-		-	
MODEL SERIES AO AOR-INCLUDES BYPASS		MODEL SIZE SELECTED		NUMBER OF PASSES BLANK - NO BYPASS 1 = ONE PASS 2 = TWO PASS		CONNECTION TYPE BLANK = NPT S - SAE M - METRIC		RELIEF BYPASS SETTING AO = NO BYPASS AOR = 30 - 30 PSI 60 - 60 PSI		FOOT MOUNTING BRACKETS BLANK - NO BRACKETS FB - FOOT BRACKETS

SPECIFICATIONS

ELECTRIC MOTOR & FAN DATA*

AO/AOVH/AOF
air cooled

Model No.	CFM	Sound dB(A)** at 7 ft.	Horse Power	Volts	Phase	Full Load Amps	Hz	Nema Frame	RPM	Type	Circuit	Thermal Overload	Bearing B-Ball S-Sleeve
AO-5	401/487	68	1/12	110/115	1	1.2/1.2	50/60	48	1400/1700	TEAO	A	No	B
	494	70	1/4	208-230/460	3	1.4-1.3/.65	60						
AO-10	576/700	68	1/12	110/115	1	1.2/1.2	50/60	48	1400/1700	TEAO	A	No	B
	710	70	1/4	208-230/460	3	1.4-1.3/.65	60						
AO-15	824/1000	69	1/12	110/115	1	1.2/1.2	50/60	48	1400/1700	TEAO	A	No	B
	1015	71	1/4	208-230/460	3	1.4-1.3/.65	60						
AO-20	1555	70	1/6	115/208-230	1	4/2.1-2	60	48	1725	TEFC	C	No	B
		72	1/4	208-230/460	3	1.4-1.3/.65	60						
AO-25	2240	72	1/6	115/208-230	1	4.6/2.2	60	48	1140	TEFC	C	No	B
		73	1/4	208-230/460	3	1.3-1.2/.6	60						
AO-30	3100	75	1/6	115/208-230	1	5.2/2.7-2.6	60	48	1140	TEFC	C	No	B
		76	1/4	208-230/460	3	1.3-1.2/.6	60						
AO-35	4370	76	1/2	115/208-230	1	8/4.2-4	60	56	1140	TEFC	C	No	B
		77	1/4	208-230/460	3	2.5-2.4/1.2	60						
AO-40	5450	78	1/2	115/208-230	1	8/4.2-4	60	56	1140	TEFC	C	No	B
		79	1/4	208-230/460	3	2.5-2.4/1.2	60						

*Published electrical ratings are approximate, and may vary because of motor brand. Actual ratings are on motor nameplate.

**Catalog dB(A) sound levels are at seven (7) feet. dB(A) sound levels increase by six (6) dB(A) for halving this distance and decrease by six (6) dB(A) for doubling this distance.

EXPLOSION PROOF MOTORS (CLASS I GP.D & CLASS II GP.F,G)*

Model No.	CFM	Sound dB(A)* at 7 ft.	Horse Power	Volts	Phase	Full Load Amps	Hz	Nema Frame	RPM	Type	Circuit	Thermal Overload	Bearing B-Ball S-Sleeve
AO-5	494	68	1/4	115/230	1	5.8/2.9	60	48	1725	FC	C	Yes	B
		70	3/4	208-230/460	3	1.4-1.3/.65	60						
AO-10	710	68	1/4	115/230	1	5.8/2.9	60	48	1725	FC	C	Yes	B
		70	3/4	208-230/460	3	1.4-1.3/.65	60						
AO-15	1015	69	1/4	115/230	1	5.8/2.9	60	48	1725	FC	C	Yes	B
		71	3/4	208-230/460	3	1.4-1.3/.65	60						
AO-20	1555	70	1/4	115/230	1	5.8/2.9	60	48	1725	FC	C	Yes	B
		72	3/4	208-230/460	3	1.4-1.3/.65	60						
AO-25	2240	72	1/3	115/230	1	6.8/3.4	60	56	1140	FC	C	Yes	B
		73	3/4	208-230/460	3	1.8-1.6/.8	60						
AO-30	3100	75	1/3	115/230	1	6.8/3.4	60	56	1140	FC	C	Yes	B
		76	3/4	208-230/460	3	1.8-1.6/.8	60						
AO-35	4370	76	1/2	115/230	1	8/4	60	56	1140	FC	C	Yes	B
		77	3/4	208-230/460	3	2.5-2.4/1.2	60						
AO-40	5450	78	1/2	115/230	1	8/4	60	56	1140	FC	C	Yes	B
		79	3/4	208-230/460	3	2.5-2.4/1.2	60						

*Published electrical ratings are approximate, and may vary because of motor brand. Actual ratings are on motor nameplate.

INSTALLATION PIPING DIAGRAMS

ONE OIL PASS

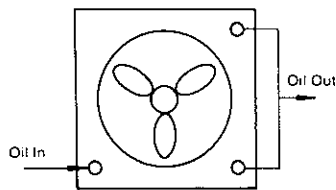

TWO OIL PASSES

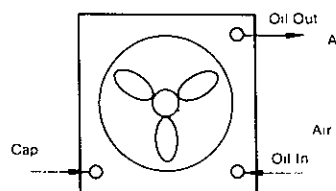

FAN ROTATION CLOCKWISE/FACING MOTOR SHAFT

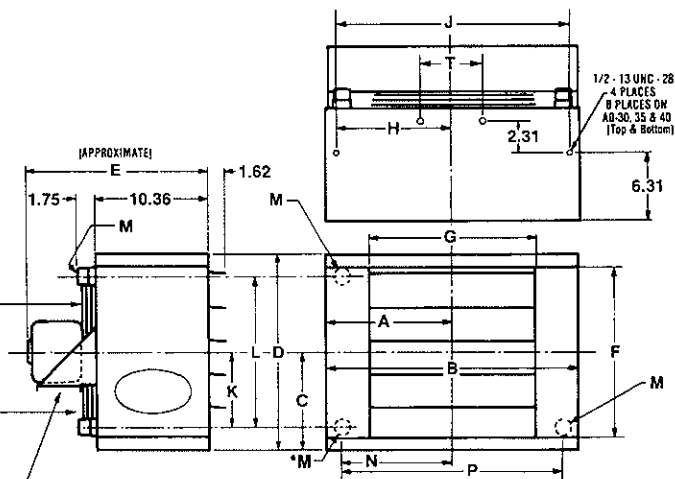

*See dimension chart for NPT or optional internal SAE connection size.

PERFORMANCE CURVES

ONE PASS OIL

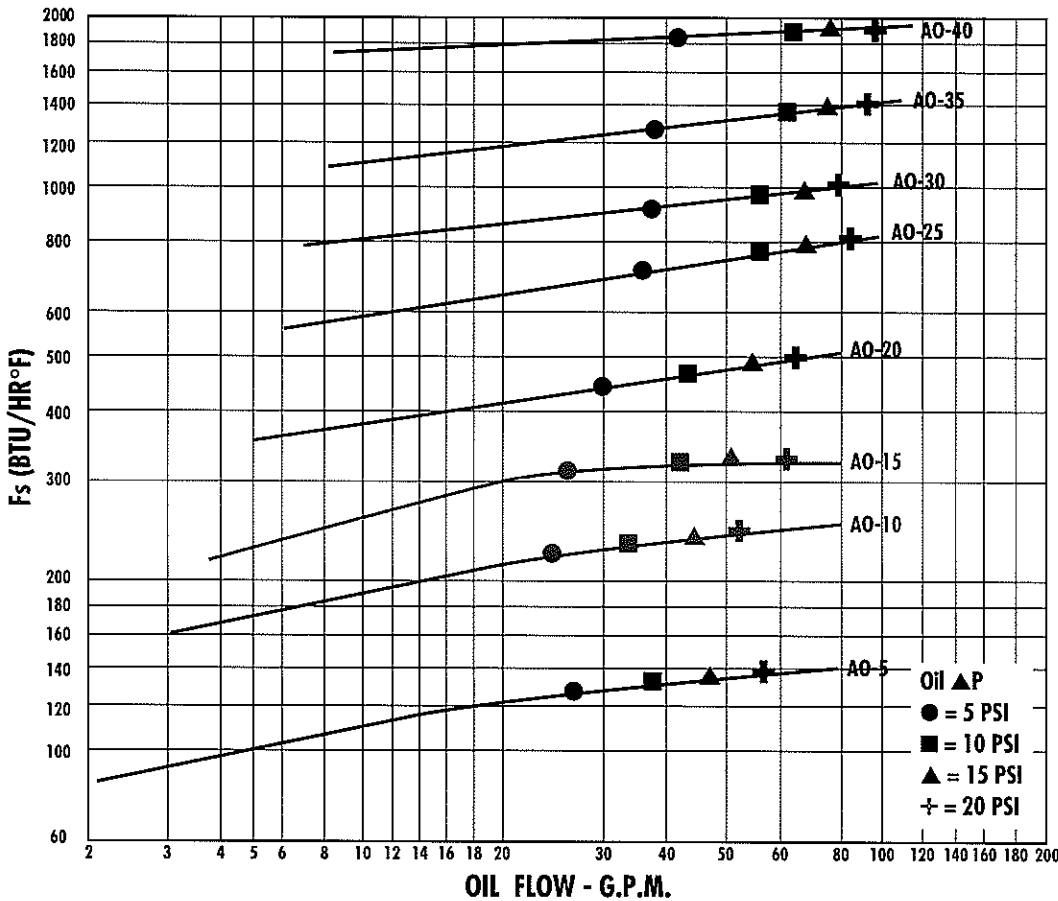

Performance Curves
50 SSU Average Viscosity Oil

$$F_s = \frac{\text{Horsepower to be removed} \times 2545 \times C_v}{\Delta T}$$

°F (Oil leaving - Ambient Air Entering)

air cooled
AO/AOVH/AOF

*Generally represents desired maximum oil temperature in the hydraulic reservoir, when used in the return line of a hydraulic system.

**After model selection has been made, record whether the selection was taken from the one or two pass curve so that the ultimate installer can pipe it up to coincide with the original sizing. Incorrect installation can seriously affect the performance and life of the cooler.

C_v VISCOSITY CORRECTION

Average Oil Temp. °F	OIL								
	SAE 5 110 SSU at 100°F 40 SSU at 210°F	SAE 10 150 SSU at 100°F 43 SSU at 210°F	SAE 20 275 SSU at 100°F 50 SSU at 210°F	SAE 30 500 SSU at 100°F 65 SSU at 210°F	SAE 40 750 SSU at 100°F 75 SSU at 210°F	50-50 Ethylene Glycol & Water	Poly Glycol 195 SSU at 100°F 52 SSU at 210°F	Phosphate Ester 233 SSU at 100°F 43 SSU at 210°F	Water in Oil Emulsion (~60% Oil) 375 SSU at 100°F 75 SSU at 210°F
100	1.14	1.22	1.35	1.58	1.77	1.11	1.08	1.19	.96
150	1.01	1.05	1.11	1.21	1.31	1.02	.96	1	.87
200	.99	1	1.01	1.08	1.10	.96	.92	.93	.85
250	.95	.98	.99	1	1	.95	.89	.92	.83

DIMENSIONS (INCHES)

Model	A	B	C	D	E	F	G	H	J	K	L	M NPT	M SAE	N	P	T
AO-5	7.40	14.81	5.90	11.81	20.00	9.19	8.31	6.47	12.94	3.78	7.56	1"	#16 SAE	5.84	11.69	—
AO-10	9.50	19.00	6.56	13.12	19.25	10.50	12.50	8.56	17.12	4.44	8.88	1"	1-5/16-12UN-2B Thread	7.94	15.88	—
AO-15	10.19	20.38	7.87	15.75	19.25	13.12	13.88	9.25	18.50	5.75	11.50	1"	Thread	8.62	17.25	—
AO-20	11.91	23.81	9.19	18.38	19.25	15.75	17.91	10.90	21.81	7.00	14.00	1-1/4"	Thread	10.28	20.56	—
AO-25	13.34	26.68	11.81	23.62	19.25	21.00	20.19	12.40	24.81	9.62	19.25	1-1/4"	#20 SAE	11.78	23.56	—
AO-30	15.81	31.62	13.78	27.56	19.50	24.94	25.12	14.87	29.75	11.59	23.19	1-1/4"	1-5/8-12UN-2B Thread	14.25	28.50	11.00
AO-35	16.90	33.81	15.09	30.19	21.50	27.56	27.31	15.97	31.94	12.90	25.81	1-1/4"	Thread	15.34	30.69	11.00
AO-40	20.81	41.62	18.37	36.75	20.50	34.12	35.12	19.87	39.75	16.19	32.38	1-1/4"	Thread	19.25	38.50	13.25

PERFORMANCE CURVES

TWO PASS OIL

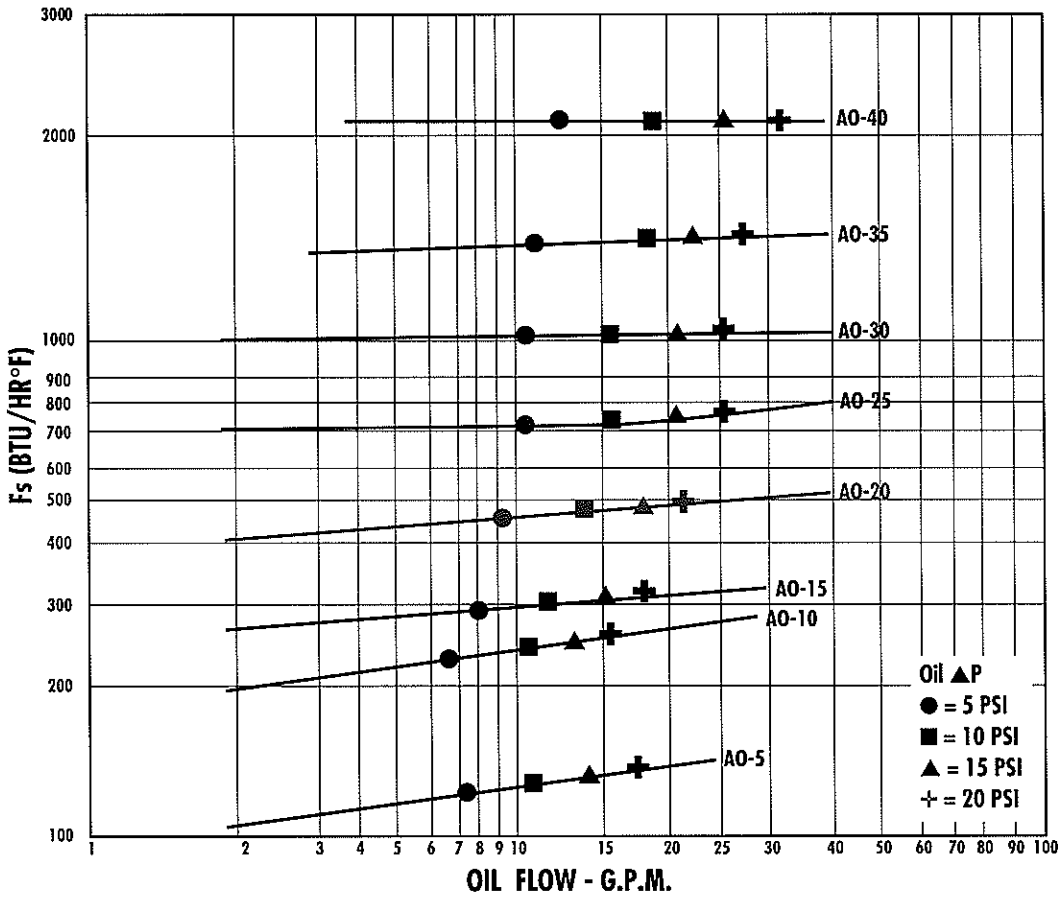

*Generally represents desired maximum oil temperature in the hydraulic reservoir, when used in the return line of a hydraulic system.

**After model selection has been made, record whether the selection was taken from the one or two pass curve so that the ultimate installer can pipe it up to coincide with the original sizing. Incorrect installation can seriously affect the performance and life of the cooler.

C_p OIL PRESSURE DROP MULTIPLIER

Average Oil Temp. °F	OIL					50-50 Ethylene Glycol & Water	Poly Glycol	Phosphate Ester	Water In Oil Emulsion (~60% Oil)
	SAE 5 110 SSU at 100°F 40 SSU at 210°F	SAE 10 150 SSU at 100°F 43 SSU at 210°F	SAE 20 275 SSU at 100°F 50 SSU at 210°F	SAE 30 500 SSU at 100°F 65 SSU at 210°F	SAE 40 750 SSU at 100°F 75 SSU at 210°F				
100	1.46	1.66	2.21	3.52	4.97	1.12	1.46	1.70	1.62
150	1.02	1.17	1.39	1.66	1.93	.91	1.22	1.34	1.32
200	.90	.92	1.05	1.16	1.37	.77	1.13	1.22	1.16
250	.83	.84	.88	.95	1.08	.68	1.09	1.18	1.09

LUBRICATION NOTES:

Ball bearings: No grease needed at start up. Grease as follows:

5,000 Hrs./Yr. Continuous Normal Applications	5 Yr. Grease Interval 2 Yr. Grease Interval
Seasonal Service Motor is idle for 6 months or more	1 Yr. Grease Interval
Continuous High ambients, dirty or moist locations, high vibration	6 Month Grease Interval

Caution: Do not over oil or over grease.

TEFC = Totally enclosed, fan cooled

TEAO = Totally enclosed, air cooled

FC = Fan cooled

A. Permanent-Split capacitor

C. Capacitor start-Induction run

D. Squirrel Cage

AIR COOLED EIGHT MODELS/AOVH SERIES

COMPACT

HIGH PERFORMANCE

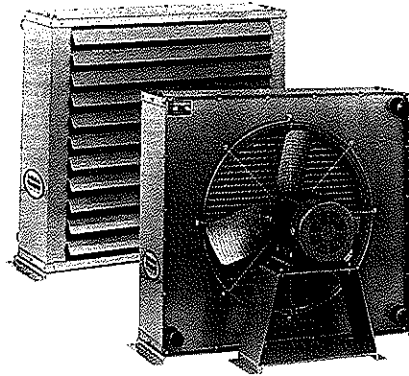

air cooled
AO/AOVH/AOF

- Fluid Power Systems
- Gear Drives
- Injection Molding Machines
- Machine Tools
- Torque Converters
- Hydraulic Presses

OPTIONS:

- Internal SAE Straight Threads
- SAE & Metric Connections
- Relief Bypass

MATERIALS

Tubes - Copper

Fins - Aluminum

Turbulators - Steel

Fan Blade - Aluminum with steel hub

Fan Guard - Zinc plated steel

Cabinet and Mounting Base - Steel with baked enamel finish

Manifolds and Connection Pipes - Steel

RATINGS

Operating pressure - 300 psi

Operating temperature - 400°F

AOVHR SERIES

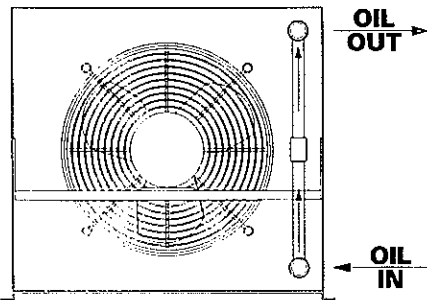

TWO PASS ONLY

(LOW TO MEDIUM OIL FLOWS)

Model	Flow Range GPM (USA)
AOVHR - 5 - 2	4 - 50
AOVHR - 10 - 2	4 - 60
AOVHR - 15 - 2	4 - 60
AOVHR - 20 - 2	4 - 80
AOVHR - 25 - 2	4 - 80
AOVHR - 30 - 2	4 - 80
AOVHR - 35 - 2	6 - 80
AOVHR - 40 - 2	8 - 80

Model	Net Weights (LBS.)
AOVHR-5	67
-10	78
-15	90
-20	110
-25	157
-30	190
-35	315
-40	350

HOW TO ORDER

MODEL SERIES AOVH AOVHR=INCLUDES BYPASS	MODEL SIZE SELECTED	NUMBER OF PASSES BLANK - NO BYPASS 2 = TWO PASS ONLY	CONNECTION TYPE BLANK = NPT S - SAE M - METRIC	RELIEF BYPASS SETTING AOVH = NO BYPASS AOVHR = 30 - 30 PSI 60 - 60 PSI

PERFORMANCE CURVES

ONE PASS OIL (AOVH)

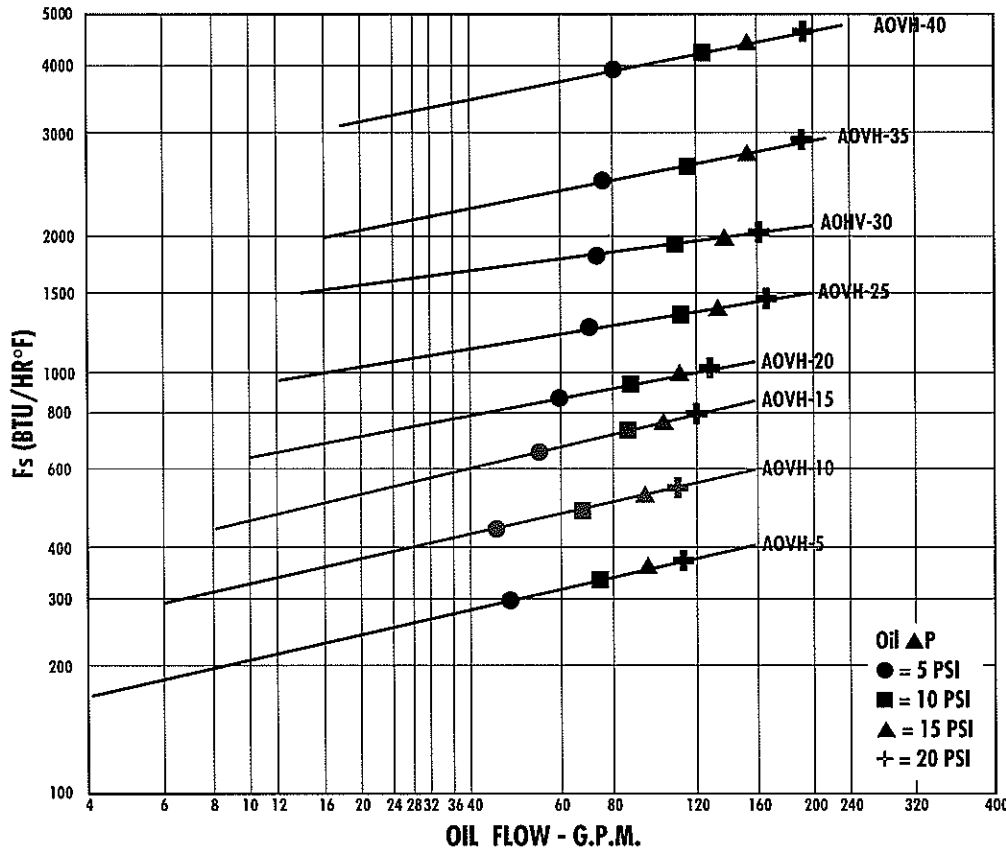

Performance Curves

50 SSU Average Viscosity Oil

$$F_s = \frac{\text{Horsepower to be removed} \times 2545 \times C_v}{\text{°F (Oil leaving - Ambient Air Entering)}}$$

AO/AOVH/AOF
air cooled

*Generally represents desired maximum oil temperature in the hydraulic reservoir, when used in the return line of a hydraulic system.

**After model selection has been made, record whether the selection was taken from the one or two pass curve so that the ultimate installer can pipe it up to coincide with the original sizing. Incorrect installation can seriously affect the performance and life of the cooler.

C_v VISCOSITY CORRECTION

Average Oil Temp. °F	OIL					50-50 Ethylene Glycol & Water	Poly Glycol	Phosphate Ester	Water In Oil Emulsion (~60% Oil)
	SAE 5 110 SSU at 100°F 40 SSU at 210°F	SAE 10 150 SSU at 100°F 43 SSU at 210°F	SAE 20 275 SSU at 100°F 50 SSU at 210°F	SAE 30 500 SSU at 100°F 65 SSU at 210°F	SAE 40 750 SSU at 100°F 75 SSU at 210°F				
100	1.14	1.22	1.35	1.58	1.77	1.11	1.08	1.19	.96
150	1.01	1.05	1.11	1.21	1.31	1.02	.96	1	.87
200	.99	1	1.01	1.08	1.10	.96	.92	.93	.85
250	.95	.98	.99	1	1	.95	.89	.92	.83

DIMENSIONS (INCHES)

Model	A	B	C	D	E	F	G	K	L	M NPT	M SAE	N	P	Q	Net WL. (Lbs.)
AOVH-5	7.40	14.81	5.90	11.81	19.93	9.19	8.31	3.84	7.69	1-1/2"	#24 SAE	5.84	11.69	16.81	67
AOVH-10	9.50	19.00	6.56	13.12	19.49	10.50	12.50	4.44	8.88		1-7/8-12UN Thread	7.94	15.88	21.00	78
AOVH-15	10.19	20.38	7.87	15.75	19.49	13.12	13.88	5.75	11.50		8.62	17.25	22.38	90	
AOVH-20	11.91	23.81	9.19	18.38	19.49	15.75	17.19	7.00	14.00	2"	#32 SAE	10.28	20.56	25.81	110
AOVH-25	13.34	26.68	11.81	23.62	23.58	21.00	20.19	9.62	19.25		11.78	23.56	28.68	157	
AOVH-30	15.81	31.62	13.78	27.56	23.33	24.94	25.12	11.59	23.19		2-1/2-12UN Thread	14.25	28.50	33.62	190
AOVH-35	16.90	33.81	15.09	30.19	23.06	27.56	27.31	12.90	25.81	2"	15.34	30.69	35.81	315	
AOVH-40	20.81	41.62	18.37	36.75	23.06	34.12	35.12	16.19	32.38						19.25

SPECIFICATIONS

ELECTRIC MOTOR & FAN DATA*

AO/AOVH/AOF
air cooled

Model No.	CFM	Sound dB(A)** at 7 ft.	Horse Power	Volts	Phase	Full Load Amps	Hz	Nema Frame	RPM	Type	Circuit	Thermal Overload	Bearing B-Ball S-Sleeve
AOVH-5	780	85	1/2	115/208-230	1	7.4/3.9-3.7	60	48	3450	TEFC	C	No	B
				208-230/460	3	2.1-2/1.	60	48	3450	TEFC	D	No	B
AOVH-10	1110	85	1/2	115/208-230	1	7.4/3.9-3.7	60	48	3450	TEFC	A	No	B
				208-230/460	3	2.1-2/1.	60	48	3450	TEFC	D	No	B
AOVH-15	1590	91	1/2	115/208-230	1	7.4/3.9-3.7	60	48	3450	TEFC	A	No	B
				208-230/460	3	2.1-2/1.	60	48	3450	TEFC	D	No	B
AOVH-20	2168	91	1/2	115/208-230	1	7.4/3.9-3.7	60	48	3450	TEFC	C	No	B
				208-230/460	3	2.1-2/1.	60	48	3450	TEFC	D	No	B
AOVH-25	3000	81	1	115/208-230	1	12.4/6.5-6.2	60	56	1725	TEFC	C	No	B
				208-230/460	3	13.6-3.4/1.7	60	56	1725	TEFC	D	No	B
AOVH-30	4095	84	1	115/208-230	1	12.4/6.5-6.2	60	56	1725	TEFC	C	No	B
				208-230/460	3	13.6-3.4/1.7	60	56	1725	TEFC	D	No	B
AOVH-35	NOT AVAILABLE				1								
	5921	89	3	208-230/460	3	9-8.6/4.3	60	182T	1725	TEFC	D	No	B
AOVH-40	NOT AVAILABLE				1								
	9609	91	3	208-230/460	3	9-8.6/4.3	60	182T	1725	TEFC	D	No	B

*Published electrical ratings are approximate, and may vary because of motor brand. Actual ratings are on motor nameplate.
 **Catalog dB(A) sound levels are at seven (7) feet. dB(A) sound levels increase by six (6) dB(A) for halving this distance and decrease by six (6) dB(A) for doubling this distance.

EXPLOSION PROOF MOTORS (CLASS I GP.D & CLASS II GP.F,G)*

Model No.	CFM	Sound dB(A)* at 7 ft.	Horse Power	Volts	Phase	Full Load Amps	Hz	Nema Frame	RPM	Type	Circuit	Thermal Overload	Bearing B-Ball S-Sleeve
AOVH-5	780	85	1/2	115/230	1	7.4/3.7	60	48	3450	FC	C	Yes	B
				208-230/460	3	2.4-2.2/1.1	60	48	3450	FC	D	Yes	B
AOVH-10	1110	85	1/2	115/230	1	7.4/3.7	60	48	3450	FC	C	Yes	B
				208-230/460	3	2.4-2.2/1.1	60	48	3450	FC	D	Yes	B
AOVH-15	1590	91	1/2	115/230	1	7.4/3.79	60	48	3450	FC	C	Yes	B
				208-230/460	3	2.4-2.2/1.1	60	48	3450	FC	D	Yes	B
AOVH-20	2168	91	1/2	115/230	1	7.4/3.79	60	48	3450	FC	C	Yes	B
				208-230/460	3	2.4-2.2/1.1	60	48	3450	FC	D	Yes	B
AOVH-25	3000	81	1	115/230	1▲	12.4/6.2	60	56	1725	FC	C	Yes	B
				230/460	3	3.4/1.7	60	56	1725	FC	D	No	B
AOVH-30	34095	84	1	115/230	1▲	12.4/6.2	60	56	1725	FC	C	Yes	B
				230/460	3	3.4/1.7	60	56	1725	FC	D	No	B
AOVH-35	NOT AVAILABLE				1								
	5921	89	3	230/460	3	8.6/4.3	60	182T	1725	FC	D	No	B
AOVH-40	NOT AVAILABLE				1								
	9609	91	3	230/460	3	8.6/4.3	60	182T	1725	FC	D	No	B

*Published electrical ratings are approximate, and may vary because of motor brand. Actual ratings are on motor nameplate.

LUBRICATION NOTES:

Ball bearings: No grease needed at start up. Grease as follows:

5,000 Hrs./Yr.	5 Yr. Grease Interval
Continuous Normal Applications	2 Yr. Grease Interval
Seasonal Service Motor is idle for 6 months or more	1 Yr. Grease Interval
Continuous High ambients, dirty or moist locations, high vibration	6 Month Grease Interval

Caution: Do not over oil or over grease.

▲ CL. 1, GP. D only

TEFC = Totally enclosed, fan cooled

FC = Fan cooled

C. Capacitor start—Induction run

D. Squirrel Cage

AIR COOLED WITH AIR FILTER/AOF SERIES

air cooled
AO/AOVH/AOF

HIGH FLOWS

MODERATE HEAT REMOVAL

FILTER STANDARD

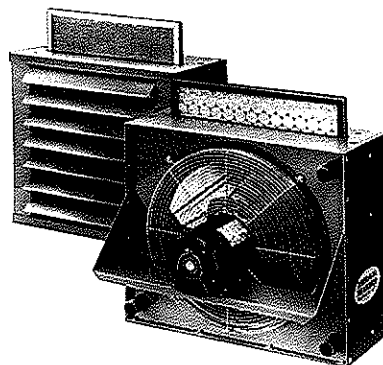

- Fluid Power Systems
- Gear Drives
- Injection Molding Machines
- Machine Tools
- Torque Converters
- Hydraulic Presses

OPTIONS:

- SAE & Metric Connections
- Built-in Bypass Relief
- Washable Aluminum Filter
- Foot Mounting Bracket
- Corrosion Resistant/Marine Duty Coating

MATERIALS

- Tubes** - Copper
- Fins** - Aluminum
- Turbulators** - Steel

- Fan Blade** - Aluminum with steel hub
- Fan Guard** - Zinc plated steel
- Cabinet** - Steel with baked enamel finish
- Manifolds and Connection Pipes** - Steel

RATINGS

- Operating pressure** - 300 psi
- Test pressure** - 450 psi
- Operating temperature** - 400°F

REPLACEMENT AIR FILTERS

Model	Fiberglass Disposable Type Part Number	Aluminum Washable Type Part Number
AOF - 5	65528	65559
AOF - 10	65530	65560
AOF - 15	65507	65561
AOF - 20	65532	65562
AOF - 25	65519	65563
AOF - 30	65535	65564
AOF - 35	65537	65565
AOF - 40	65543	65566

Model	Net Weights (LBS.)
AOF-5	60
AOF-10	70
AOF-15	80
AOF-20	95
AOF-25	125
AOF-30	140
AOF-35	165
AOF-40	230

HOW TO ORDER

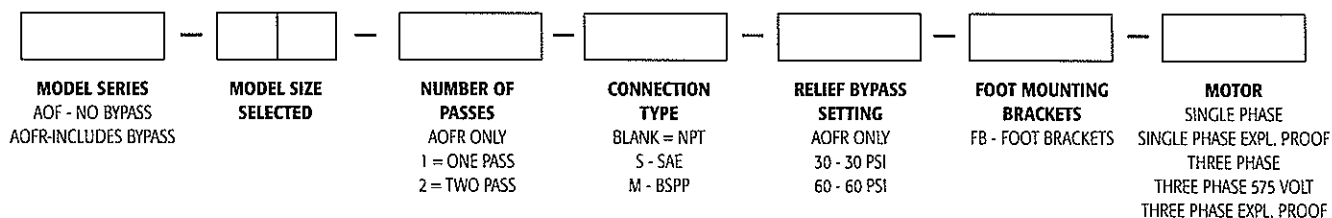

PERFORMANCE CURVES

ONE PASS OIL

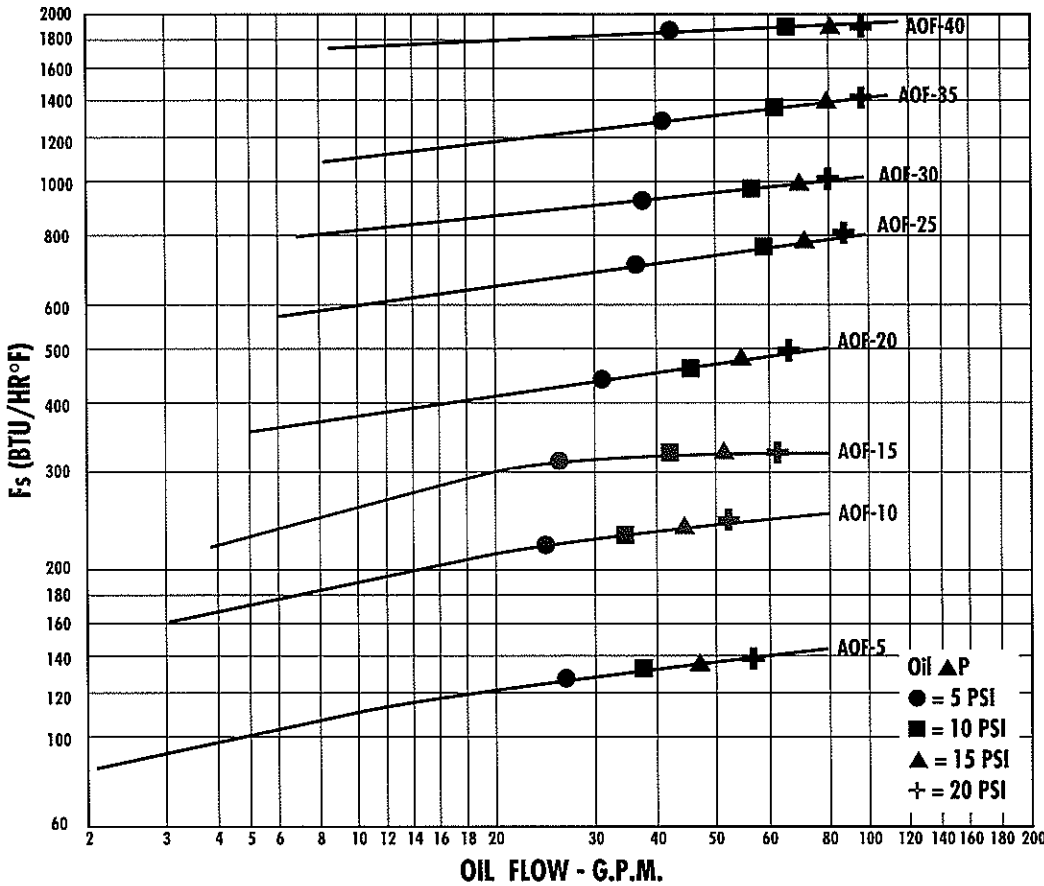

Performance Curves
50 SSU Average Viscosity Oil

$$F_s = \frac{\text{Horsepower to be removed} \times 2545 \times C_v}{\Delta T \text{ (Oil leaving - Ambient Air Entering)}}$$

AO/AOVH/AOF
air cooled

*Generally represents desired maximum oil temperature in the hydraulic reservoir, when used in the return line of a hydraulic system.
**After model selection has been made, record whether the selection was taken from the one or two pass curve so that the ultimate installer can pipe it up to coincide with the original sizing. Incorrect installation can seriously affect the performance and life of the cooler.

C_v VISCOSITY CORRECTION

Average Oil Temp. °F	OIL								
	SAE 5	SAE 10	SAE 20	SAE 30	SAE 40	50-50 Ethylene Glycol & Water	Poly Glycol	Phosphate Ester	Water In Oil Emulsion (~60% Oil)
	110 SSU at 100°F 40 SSU at 210°F	150 SSU at 100°F 43 SSU at 210°F	275 SSU at 100°F 50 SSU at 210°F	500 SSU at 100°F 65 SSU at 210°F	750 SSU at 100°F 75 SSU at 210°F		195 SSU at 100°F 52 SSU at 210°F	233 SSU at 100°F 43 SSU at 210°F	375 SSU at 100°F 75 SSU at 210°F
100	1.14	1.22	1.35	1.58	1.77	1.11	1.08	1.19	.96
150	1.01	1.05	1.11	1.21	1.31	1.02	.96	1	.87
200	.99	1	1.01	1.08	1.10	.96	.92	.93	.85
250	.95	.98	.99	1	1	.95	.89	.92	.83

DIMENSIONS

Model	A	B	C	D	E	F	G	H	J	K	L	M NPT	M SAE	N	P	Q	R	S	T
AOF-5	7.40	14.81	5.90	11.81	17.50	9.19	8.31	6.47	12.94	3.78	7.69	1"	#16 SAE	5.84	11.69	10.06	1.09	3.92	-
AOF-10	9.50	19.00	6.56	13.12	17.00	10.50	12.50	8.56	17.12	4.44	8.88	1"	1-5/16-12UN-2B Thread	7.94	15.88	14.38	1.09	3.92	-
AOF-15	10.19	20.38	7.87	15.75	17.62	13.12	13.88	9.25	18.50	5.75	11.50	1"		8.62	17.25	15.62	1.09	3.92	-
AOF-20	11.91	23.81	9.19	18.38	19.62	15.75	17.91	10.90	21.81	7.00	14.00	1-1/4"	#20 SAE	10.28	20.56	18.62	1.09	3.92	-
AOF-25	13.34	26.68	11.81	23.62	20.68	21.00	20.19	12.40	24.81	9.62	19.25	1-1/4"		11.78	23.56	21.62	1.09	3.92	-
AOF-30	15.81	31.62	13.78	27.56	20.12	24.94	25.12	14.87	29.75	11.59	23.19	1-1/4"	1-5/8-12UN-2B Thread	14.25	28.50	26.62	1.09	3.92	11.00
AOF-35	16.90	33.81	15.09	30.19	21.25	27.56	27.31	15.97	31.94	12.90	25.81	1-1/4"		15.34	30.69	28.88	1.09	3.94	11.00
AOF-40	20.81	41.62	18.37	36.75	20.31	34.12	35.12	19.87	39.75	16.19	32.38	1-1/4"	19.25	38.50	37.00	1.18	3.87	13.25	

SPECIFICATIONS

ELECTRIC MOTOR & FAN DATA*

Model No.	CFM	Sound dB(A)** at 7 ft.	Horse Power	Volts	Phase	Full Load Amps	Hz	Nema Frame	RPM	Type	Circuit	Thermal Overload	Bearing B-Ball S-Sleeve
AOF-5	465	68	1/6	115/208-230	1	4/2.1-2	60	48	1725	TEFC	C	No	B
	494	70	1/4	208-230/460	3	1.4-1.3/.65							
AOF-10	669	68	1/6	115/208-230	1	4/2.1-2	60	48	1725	TEFC	C	No	B
	710	70	1/4	208-230/460	3	1.4-1.3/.65							
AOF-15	956	69	1/4	115/208-230	1	5.8/3-2.9	60	48	1725	TEFC	C	No	B
	1015	71		208-230/460	3	1.4-1.3/.65							
AOF-20	1460	70	1/2	115/208-230	1	7.8/4.1-3.9	60	48	1725	TEFC	C	No	B
	1555	72		208-230/460	3	2.1-2/.1							
AOF-25	2160	72	1/2	115/208-230	1	8/4.2-4	60	56	1140	TEFC	C	No	B
	2240	73		208-230/460	3	2.5-2.4/1.2							
AOF-30	2990	75	1/2	115/208-230	1	8/4.2-4	60	56	1140	TEFC	C	No	B
	3100	76		208-230/460	3	2.5-2.4/1.2							
AOF-35	NOT AVAILABLE			208-230/460	1	4-3.8/1.9	60	56	1140	TEFC	D	No	B
	4370	77	1.0		3								
AOF-40	NOT AVAILABLE			208-230/460	1	4-3.8/1.9	60	56	1140	TEFC	D	No	B
	5450	79	1.0		3								

*Published electrical ratings are approximate, and may vary because of motor brand. Actual ratings are on motor nameplate.

**Catalog dB(A) sound levels are at seven (7) feet. dB(A) sound levels increase by six (6) dB(A) for halving this distance and decrease by six (6) dB(A) for doubling this distance.

EXPLOSION PROOF MOTORS (CLASS I GP.D & CLASS II GP.F,G)*

Model No.	CFM	Sound dB(A)* at 7 ft.	Horse Power	Volts	Phase	Full Load Amps	Hz	Nema Frame	RPM	Type	Circuit	Thermal Overload	Bearing B-Ball S-Sleeve
AOF-5	494	68	1/4	115/230	1	5.8/2.9	60	48	1725	FC	C	Yes	B
		70		208-230/460	3	1.4-1.3/.65							
AOF-10	710	68	1/4	115/230	1	5.8/2.9	60	48	1725	FC	C	Yes	B
		70		208-230/460	3	1.4-1.3/.76							
AOF-15	1015	69	1/4	115/230	1	5.8/2.9	60	48	1725	FC	C	Yes	B
		71		208-230/460	3	1.4-1.3/.65							
AOF-20	1555	70	1/2	115/230	1	7.8/3.9	60	48	1725	FC	C	Yes	B
		72		208-230/460	3	2.1-2/.1							
AOF-25	2240	72	1/2	115/230	1	8/4.	60	56	1140	FC	C	Yes	B
		73		208-230/460	3	2.5-2.4/1.2							
AOF-30	3100	75	1/2	115/230	1	8/4.	60	56	1140	FC	C	Yes	B
		76		208-230/460	3	2.5-2.4/1.2							
AOF-35	NOT AVAILABLE			230/460	1	3.8/1.9	60	56	1140	FC	D	No	B
	4370	77	1.0		3								
AOF-40	NOT AVAILABLE			230/460	1	3.8/1.9	60	56	1140	FC	D	No	B
	5450	79	1.0		3								

*Published electrical ratings are approximate, and may vary because of motor brand. Actual ratings are on motor nameplate.

LUBRICATION NOTES:

Ball bearings: No grease needed at start up. Grease as follows:

5,000 Hrs./Yr.	5 Yr. Grease Interval
Continuous Normal Applications	2 Yr. Grease Interval
Seasonal Service Motor is idle for 6 months or more	1 Yr. Grease Interval
Continuous High ambients, dirty or moist locations, high vibration	6 Month Grease Interval

Caution: Do not over oil or over grease.

▼ AOF 35 & 40, CL. 1, GP. D

TEFC = Totally enclosed, fan cooled

TEAO = Totally enclosed, air over

FC = Fan cooled

C. Capacitor start—Induction run

D. Squirrel Cage

For more information or to purchase these products, please contact:

HYDROTHRIFT CORPORATION
(800) 772-0493

www.hydrothrift.com
sales@hydrothrift.com